

Rigid body

fixed positions of the mass particles (also during the motion)

6x DoF !!

rigid body motion = **translation** of the mass centre
+ **rotation** about the axis passing
the mass centre

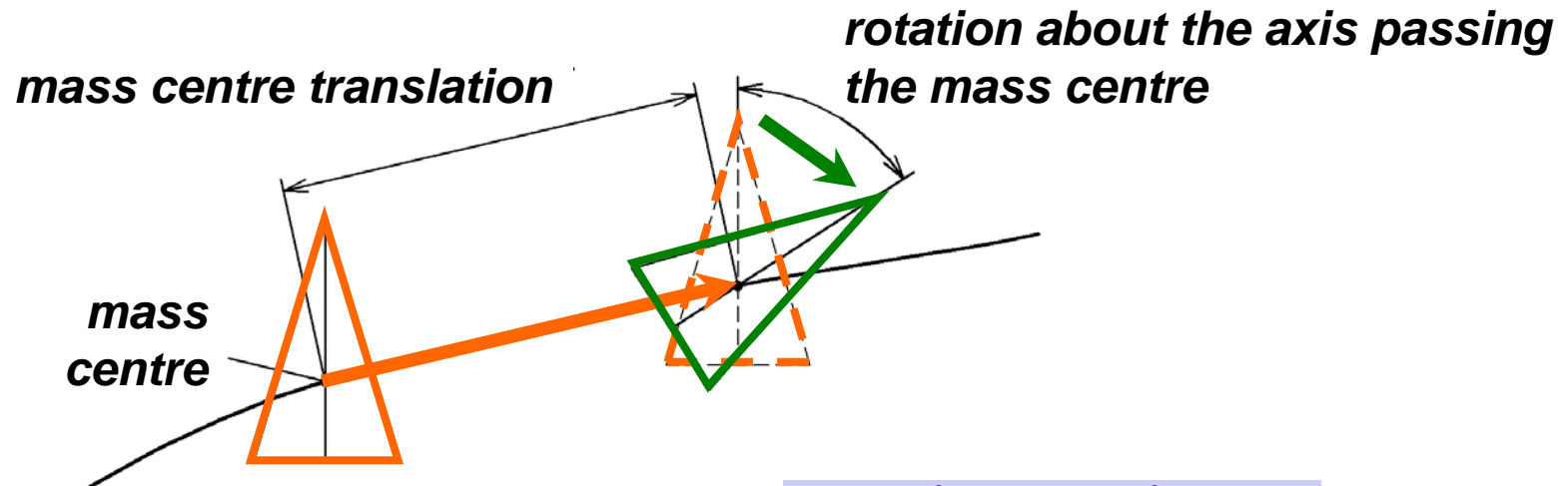

$$dm = \rho dV$$

$$m = \int_{(m)} dm = \int_{(V)} \rho dV$$

Centre of gravity

point of acting force of gravity; any torque equals zero

$$\vec{F}_g = \sum_i m_i \vec{g}$$

$$\vec{r}_T \times \vec{F}_g = \sum_i (\vec{r}_i \times m_i \vec{g})$$

$$\vec{r}_T m \times \vec{g} = \sum_i (\vec{r}_i m_i \times \vec{g})$$

$$\vec{r}_T = \frac{1}{m} \sum_i \vec{r}_i m_i$$

$$\vec{r}_T = \frac{1}{m} \int_{(m)} \vec{r} dm$$

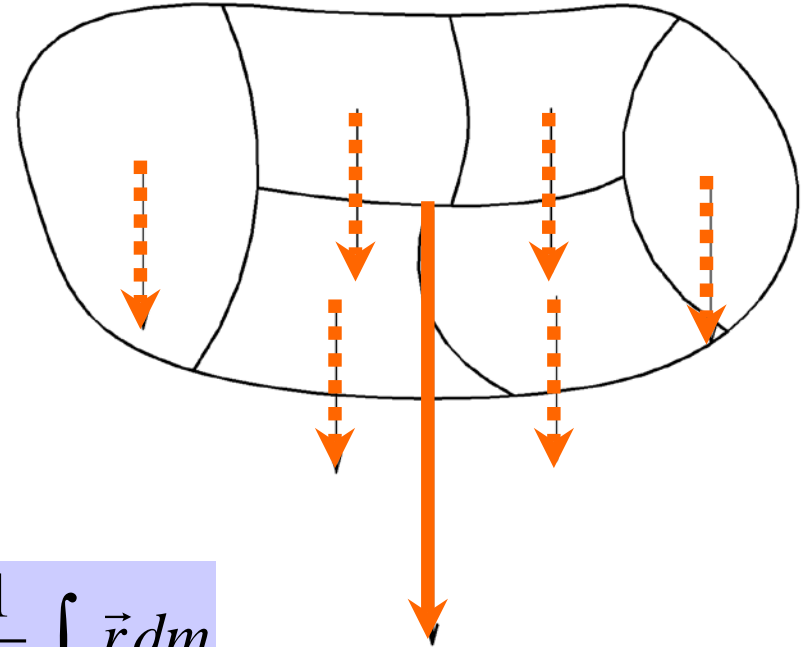

centre of gravity – homogenous bodies in homogenous field

$$\vec{r}_T = \vec{r}_s$$

Rigid body dynamics

Translation

$$\vec{F} = m \frac{d^2 \vec{r}_s}{dt^2} = \frac{d\vec{p}}{dt}$$

**force and linear
momentum equivalent**

Rotation about a fixed axis

Torque

$$\vec{M} = \vec{r} \times \vec{F}$$

$$\vec{M} = \vec{r} \times \vec{F} = \vec{r} \times \frac{d\vec{p}}{dt}$$

Angular momentum

$$\vec{L} = \vec{r} \times \vec{p} = \vec{r} \times m\vec{v}$$

$$\frac{d\vec{L}}{dt} = \frac{d}{dt} (\vec{r} \times \vec{p}) = \frac{d\vec{r}}{dt} \times \vec{p} + \vec{r} \times \frac{d\vec{p}}{dt}$$

$$\frac{d\vec{L}}{dt} = \vec{r} \times \frac{d\vec{p}}{dt} = \vec{r} \times \vec{F}$$

$$\vec{M} = \frac{d\vec{L}}{dt}$$

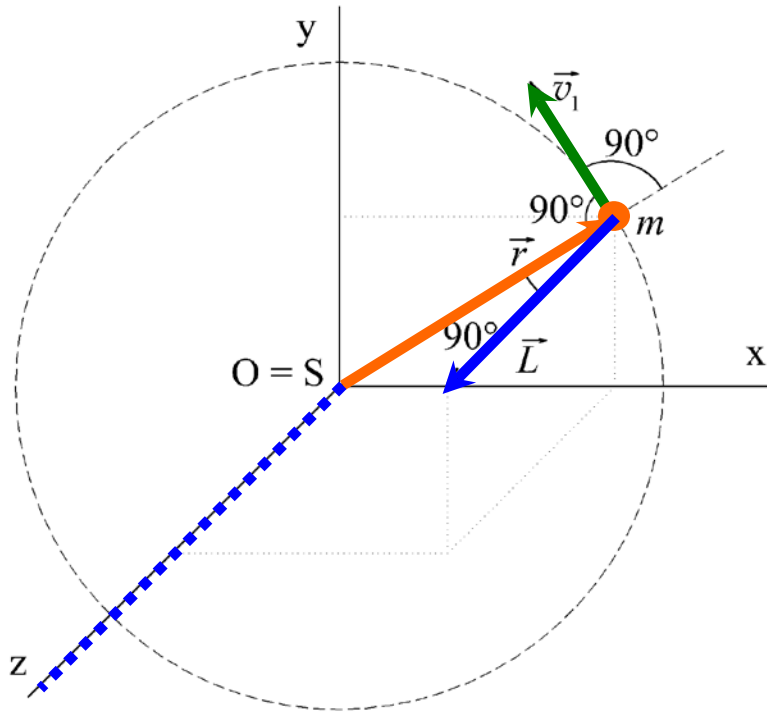

$$|\vec{L}| = |\vec{r} \times \vec{p}| = |\vec{r} \times m\vec{v}| = rmv = mr^2\omega$$

$$\vec{L} = \sum_i \vec{L}_i \quad \text{for particle system}$$

$$\vec{L}_i = m_i r_i^2 \vec{\omega}$$

$$\vec{L} = \sum_i \vec{L}_i = \left(\sum_i m_i r_i^2 \right) \vec{\omega}$$

$$\sum_i m_i r_i^2 = I \quad \vec{L} = I\vec{\omega}$$

Moment of Inertia

$$I = \int_{(m)} r^2 dm$$

$$I = I_0 + md^2$$

Steiner's theorem

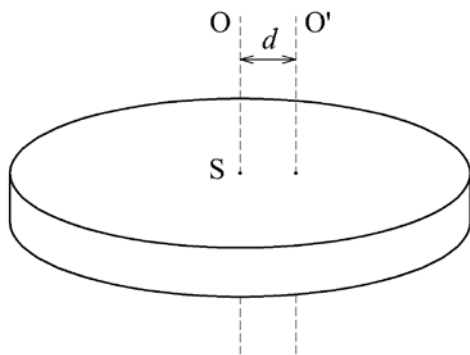

$$\vec{M} = \sum_i \vec{M}_i = \sum_i \frac{d\vec{L}_i}{dt} = \frac{d}{dt} \left(\sum_i \vec{L}_i \right) = \frac{d\vec{L}}{dt}$$

$$\vec{M} = \frac{d\vec{L}}{dt} = \frac{d(I\vec{\omega})}{dt} = I \frac{d\vec{\omega}}{dt} = I\vec{\epsilon}$$

$$\vec{M} = \sum_i \vec{M}_i = \frac{d\vec{L}}{dt}$$

Torque and angular momentum equivalent

$$\vec{M} = \sum_i \vec{M}_i = 0 = \frac{d\vec{L}}{dt} \Rightarrow \vec{L} = \overrightarrow{\text{konst}}$$

Conservation of angular momentum (CAM)

Static equilibrium of rigid body

$$\sum_i \vec{F}_i = 0$$

$$\sum_i \vec{M}_i = \sum_i (\vec{r}_i \times \vec{F}_i) = 0$$

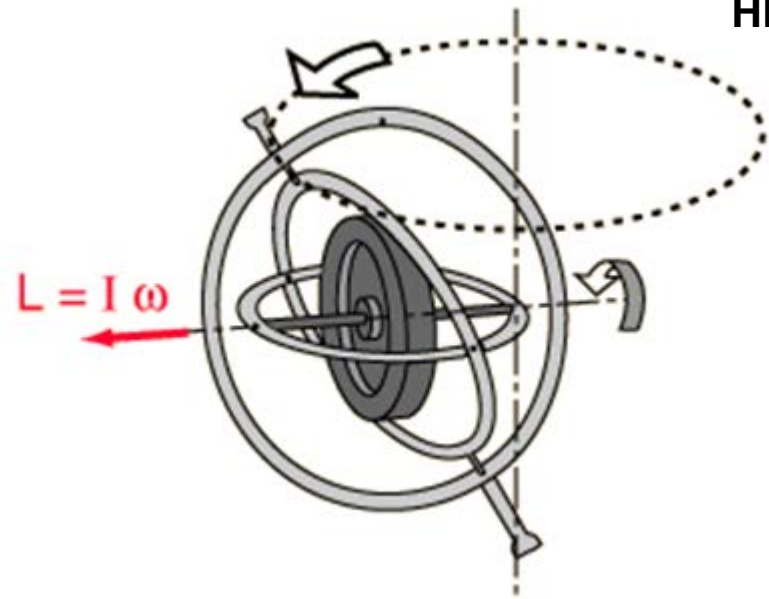
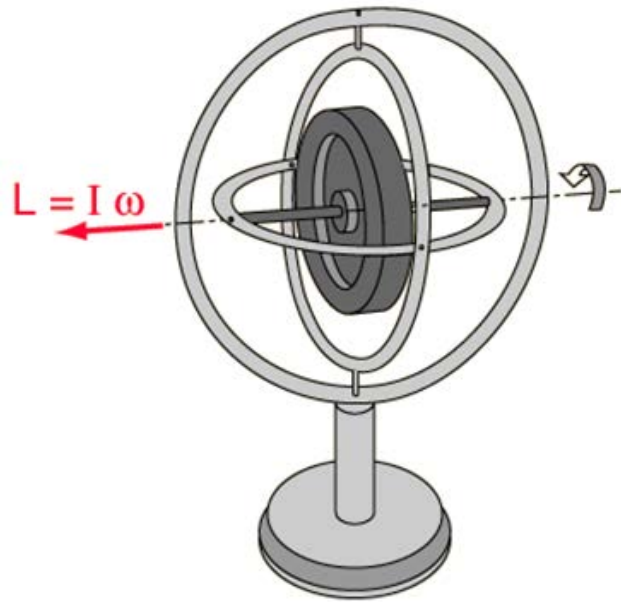

Rotational kinetic energy of a rigid body

$$ds_i = r_i d\varphi$$

$$dA_i = F_{it} ds_i = M_i d\varphi$$

$$dA = M d\varphi$$

$$P = \frac{dA}{dt} = M\omega$$

$$P = \vec{M} \cdot \vec{\omega}$$

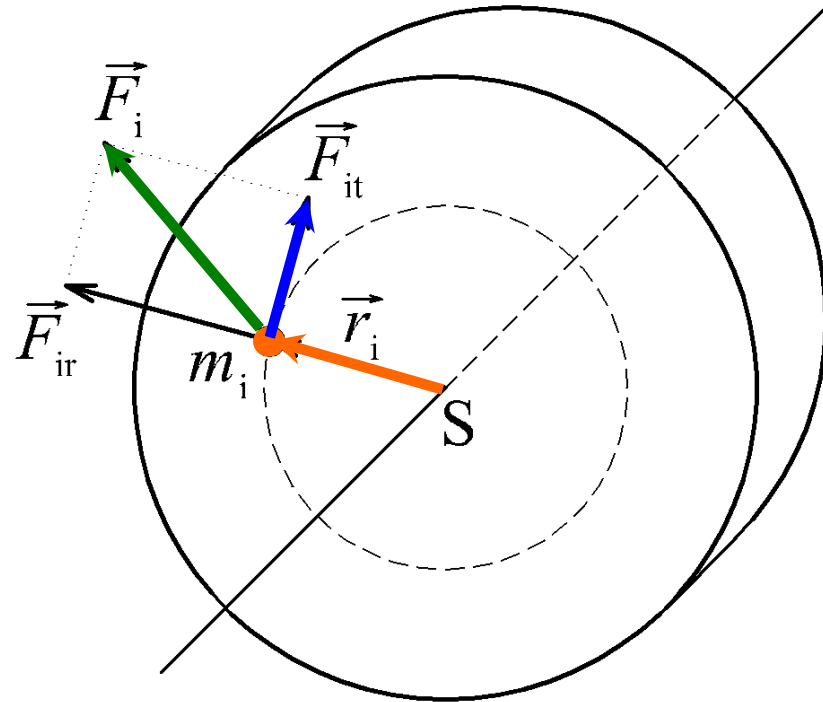

$$W_k = \sum_i \frac{1}{2} m_i v_i^2 = \sum_i \frac{1}{2} m_i r_i^2 \omega^2 = \frac{1}{2} I \omega^2$$

$$W_k = \frac{1}{2} m v^2 + \frac{1}{2} I \omega^2$$